

ARISE

New
Launch

Rise above
expectations

OTIS



Superior and versatile

You have left no stone unturned to ensure the best for your building. Here is an elevator system that matches your expectations and fulfills your needs. The Arise system focuses on delivering a blend of luxury and technology that changes how your customers, tenants or passengers experience your building.

OTIS ARISE OVERVIEW

Maximum rise	140 m
Speed	2.5 m/s
Duty load	1156 kg, 1360 kg, 1632 kg
Maximum stops	40



A reliable way to move your world

At Otis, we go above and beyond code standards to ensure the Arise elevator stands the test of time, delivering more value for your building.

+ PM GEARLESS MACHINES

The Permanent Magnet Synchronous machine is a highly efficient machine, designed and manufactured by Otis with strict engineering and quality control standards. This machine is with the Class F insulated, non-asbestos lining and a thermo-contact in the winding of the motor. All these features help passengers get to their destinations smoothly and reliably.

+ CONTROLLER & REGEN DRIVE

The controller is optimized with the standalone Otis patented ReGen drive for the machine room system. Use of energy efficient components with regenerative drive, supports to achieve better VDI targets than conventional elevator systems. The controller cabinet is designed with international protection grade IP2X. Standalone regenerative drive is mounted on the stand & can be installed near the controller & machine.

+ TOUGH LANDING DOORS

Landing doors are put through stringent impact tests, to sustain everything from day-to-day passenger interactions to more intense cart or luggage impacts, exceeding EN 81-20 & IS elevator code requirements.

+ AUTOMATIC RESCUE & EVACUATION DEVICE (ARED)

A battery-operated rescue system is standard on the Arise product. ARED rescue operation automatically moves the car to the nearest floor and opens the door for safe passenger exit even during a power failure. The ARED is qualified as per the IS code & Indian power quality requirements.

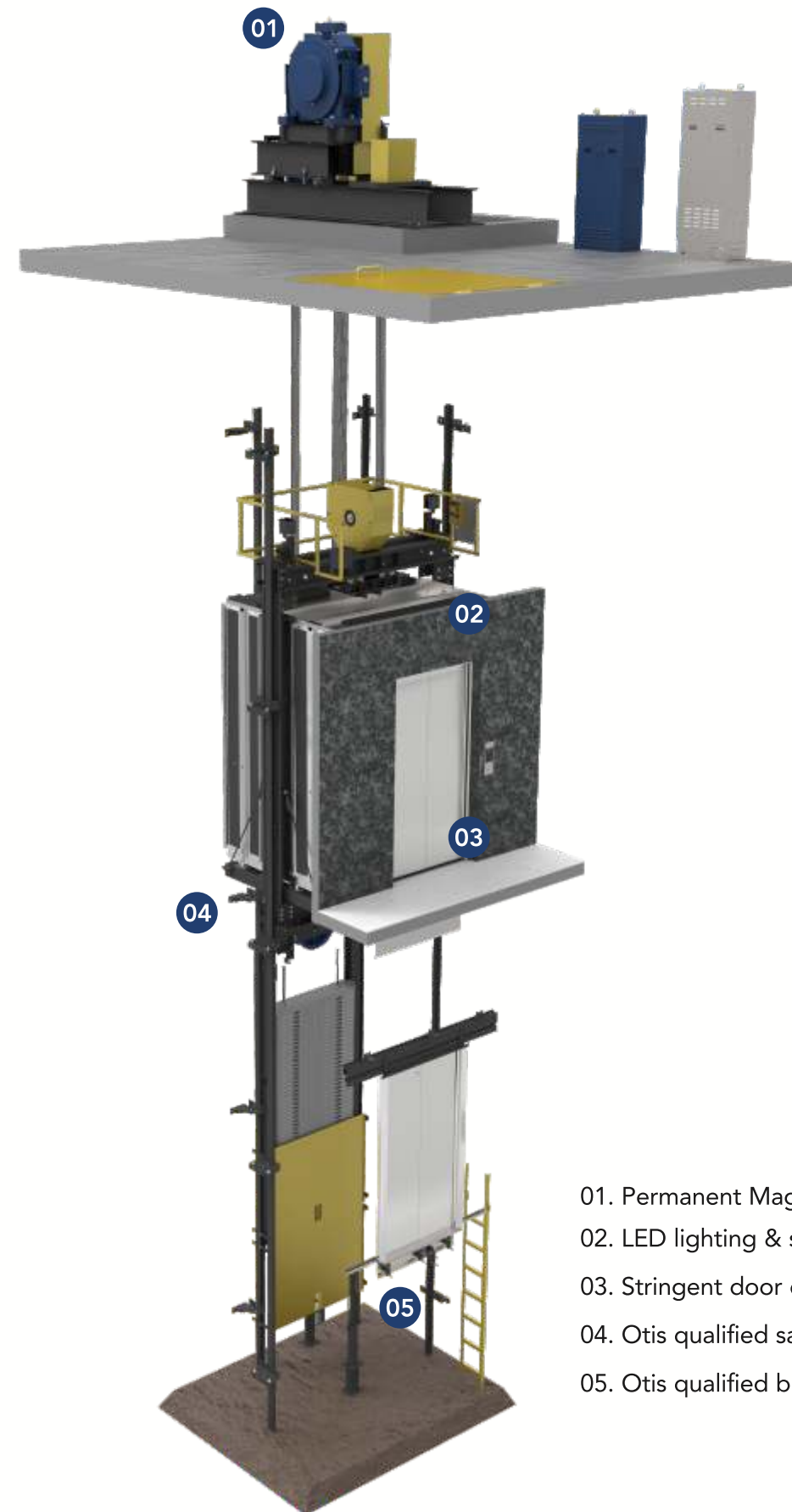

- 01. Permanent Magnet high efficiency machine
- 02. LED lighting & standby mode
- 03. Stringent door qualification
- 04. Otis qualified safety gears & over-speed governors
- 05. Otis qualified buffers

Compliance with IS code & state lift rules

Safety and peace of mind

Since the invention of the Otis safety brake, safety has been a core promise of everything we do. So it wasn't enough for us to rely on basic safety code standards. We created our own set of even more demanding guidelines surpass global standards – the Otis Worldwide E3 policy. The parts and components of the Arise elevator undergo a battery of performance, safety and lifetime qualification testing that includes more than 50 critical safety tests during the manufacturing process.

+ GOVERNOR TRIPPING TEST

25%

MORE

*Exceed application code

+ BUFFER STRIKE TESTS

16x

MORE

*Exceed application code

+ SAFETY GEAR TESTS

6x

*Compared with GB7588-2003 A1 / EN81.1-1998



Designed to deliver year after year

At Otis, quality, safety and reliability are the hallmarks of exceptional design. Manufactured exclusively at our ISO-certified Bengaluru factory to Otis' exacting standards, the Arise takes safety and reliability to new heights. It also underscores our commitment to the 'Make in India' initiative.



A commitment to exceptional service

We know what it takes to keep people safely and seamlessly on the move. Our founders were dedicated to delivering extraordinary service, and today we're continuing that promise with personalized and imaginative ways to meet our customers' every need.

+ WE EARN YOUR TRUST - EVERYDAY

Our mechanics see your building as their own. With a global team of 31,000, we work around the clock to keep your equipment operating like new. The result is a truly personalized service that ensures we build your trust over the lifetime of your equipment.

+ THE RIGHT MAINTENANCE AT THE RIGHT TIME

The Otis Maintenance Management System is a predictive and preventative system, ensuring fewer service calls and less downtime than any other plan in the industry. Our mechanics are assigned specific elevator units, keeping response time to a minimum. We'll focus on your elevator so you can focus on your building.

+ OTIS GENUINE PARTS

Our national service parts center is supported by the worldwide Otis supply chain and stocks a comprehensive range of thoroughly tested genuine spare parts.

+ CUSTOMER SUPPORT

Service comes first with OTISLINE® – our 24-hour call center – and a network of over 80 service locations, covering more than 300 cities and towns. We pride ourselves in providing 24/7 dedicated customer support and prompt professional service.



A tailored solution for every lifestyle

From office buildings to condominiums, having an elevator that completes your look is essential for your project and brand. With options such as hairline stainless steel and soft LED lighting, the Arise elevator will make your building stand out from the rest.



CAR OPERATING PANEL



LCD Display (Base)



TFT-LCD Display (Option)



Push button with braille

All fixtures are available in stainless steel hairline, stainless steel mirror and stainless steel gold.

CEILING



SS - N08

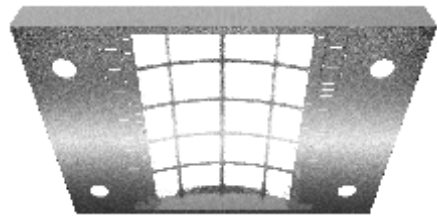

SS - N06

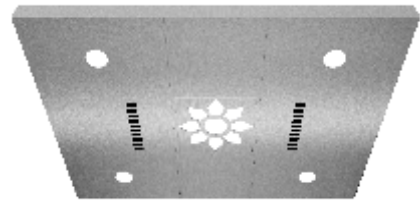

SS - J015
(Standard)

Available in powder painted, stainless hairline and stainless steel mirror finish

HALL LANTERNS



Vertical



Horizontal

All fixtures are available in stainless steel hairline, stainless steel mirror and stainless steel gold. However, pan type hall fixtures are not available in stainless steel gold.

HALL OPERATING PANEL



Pan



Flat

Monochrome Colour LCD

HANDRAILS



Base Colours



Munshell Grey



Cream



D. A. Grey

Textured Colours



Dark Grey



Antique Copper

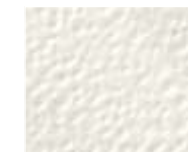

Broken White



Siemens Grey

Classic Colours



Desert Sand



GP Silver Grey

Metal finishes



Hairline

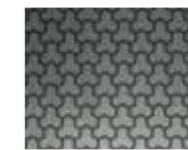

Honeycomb

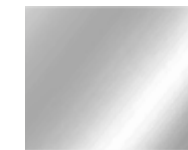

Mirror



Mirror Gold



Interlock



Splendour Maze



Polka Delite



Maple Glory

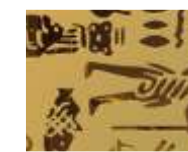

Egyptian Gold

Flooring (vinyl)



Sea Blue



Pink



Almond



White

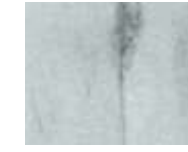

Grey



Steel Grey

Colours and finishes shown are indicative. Please allow for minor variations.

Arise specifications

PERSONS		17	17	20	20	20	24	24
DUTY LOAD (kg)		1156-W1	1156-W2	1360-W1	1360-W2	1360-D1	1632-W1	1632-D1
CAR SIZE	WIDTH (CW)	2000	1800	2000	1800	1300	2000	1500
	DEPTH (CD)	1350	1500	1550	1700	2400	1800	2400
	HEIGHT (CRH)	2400	2400	2400	2400	2400	2400	2400
DOOR	OPENING HEIGHT (OPH)	2100	2100	2100	2100	2100	2100	2100
	DOOR TYPE	CO	CO	CO	CO	2SP	CO	2SP
	OPENING WIDTH (OP)	1000	1000	1100	1000	1200	1100	1200
HOISTWAY SIZE	WIDTH (HW)	2650	2450	2650	2450	2300	2650	2400
	DEPTH (HD)	2150	2300	2300	2500	2900	2550	2900

OPTIONAL OPENING HEIGHT OF 2400mm IS AVAILABLE WITH CRH OF 2700mm.

SPEED (MPS)	2.5	
OPENING HEIGHT	2100	2400
OVERHEAD OPTION (K)	5200	5500
PIT OPTIONS (S)	2250	2250
MAXIMUM NUMBER OF STOPS	40	40
MAXIMUM RISE (METERS)	140	140
CARS IN A GROUP	Upto 8	Upto 8

FOR WEST BENGAL, OVERHEAD OF 5500mm IS REQUIRED FOR OPH OF 2100mm.

FOR GUJARAT -

- OVERHEAD OF 6900mm IS REQUIRED FOR OPH OF 2100mm.
- PIT DEPTH OF 2600mm IS REQUIRED.

ALL DIMENSIONS ARE IN mm.

GEARLESS: (WITH MACHINE-ROOM) Speed=2.5MPS

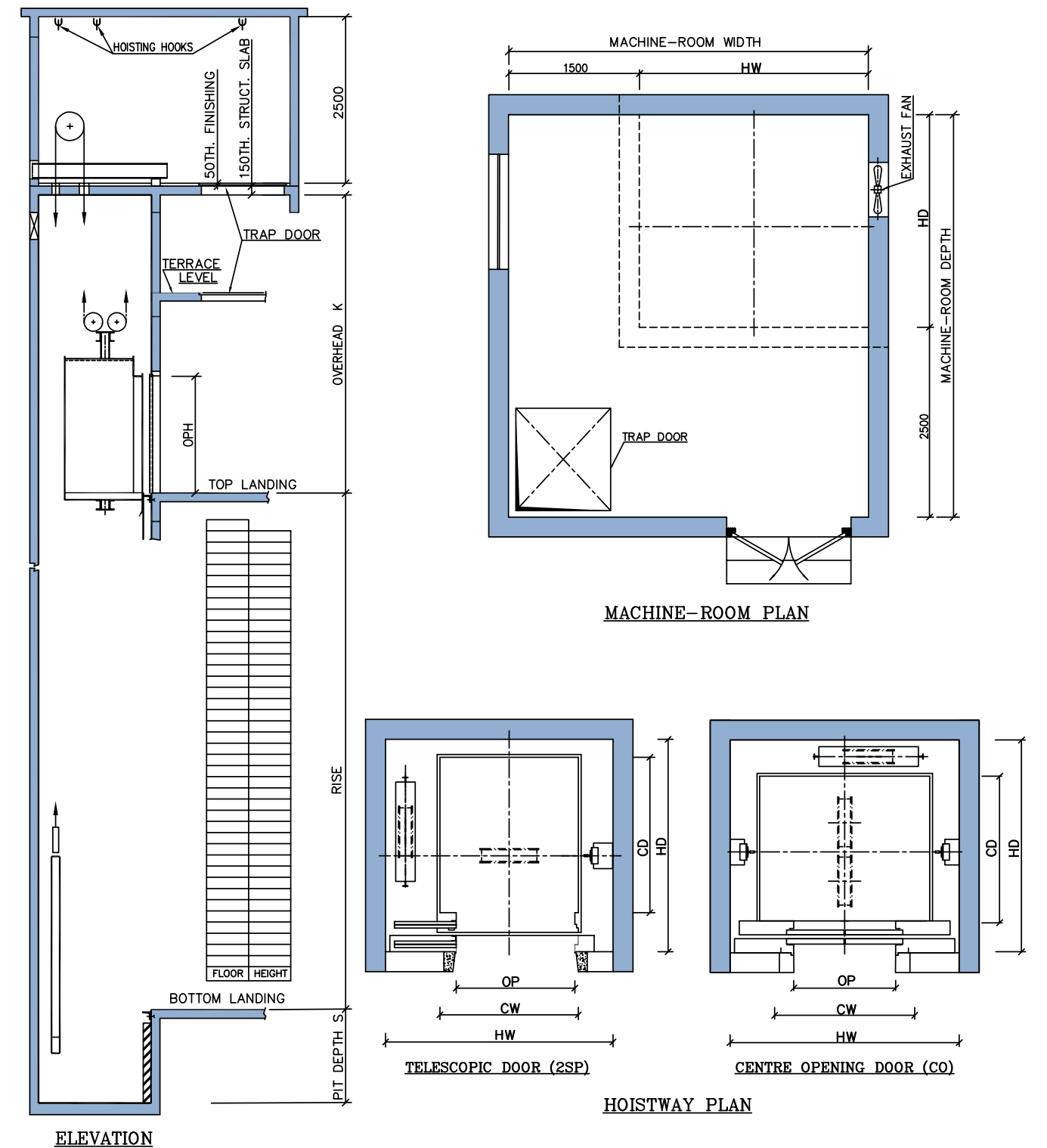

REFER OTIS DETAILED DRAWING FOR ADDITIONAL INFORMATION

ALL DIMENSIONS ARE IN mm.

Details of product design are subject to change

Let's build something unique, together

For more than 160 years, Otis has set the gold standard in the industry. But leading the industry means more than being first – we improve what we do each and every day.

From helping commuters with a reliable daily route to guiding travelers to new adventures, we help more than 2 billion people get to their next destination each day. And we care for every single one.

We take the experience we've gained from building and installing approximately 2.6 million Otis elevators and escalators in nearly 200 countries and use it to continually build our strengths to move our products toward higher standards.

ARISE ELEVATORS COMPLEMENT OTHER VERSATILE OTIS PRODUCTS

- +** **GEN2 ELEVATORS**
High-performance elevator series for residential and commercial buildings.
- +** **LINK & CROSSLINK**
Escalators and moving walkways for retail buildings, airports and metros.
- +** **SKYRISE ELEVATORS**
Elevators for high-rise buildings.
- +** **COMPASSPLUS**
Destination dispatching for efficient traffic management in your building.



Otis Elevator Company is the world's leading manufacturer and maintainer of elevators, escalators and moving walkways.

Founded more than 160 years ago by the inventor of the safety elevator, Otis offers products and services through its companies in nearly 200 countries and territories, and maintains approximately 2 million elevators and escalators worldwide. Every day, Otis moves more than 2 billion people through the world's urban landscapes.

Otis is a unit of United Technologies Corporation (UTC), a leader in the global building systems and aerospace industries. For more information, visit www.otis.com. Follow us on Twitter @OtisElevatorCo.

OFFICES:

Head Office & Western Region
(Mumbai Operations):
Otis Elevator Company (India) Ltd.,
9th Floor, Magnus Tower,
Mindspace, Link Road,
Malad (West), Mumbai - 400 064.
Tel.: +91-022-28449700 / 66795151,
Email: response@otis.com

Eastern Region:
Otis Elevator Co. (I) Ltd.
Victoria Park, Level 2
Block : GN, Plot no. 37/2
Sector V, Salt Lake
Kolkata - 700091
Tel.: 033 - 40524300

Northern Region:
271 & 272, Aggarwal Cyber Plaza-II,
C-7, Netaji Subash Place, Pitampura,
New Delhi - 110034.
Tel.: +91-011-46069000 / 46069211 /
46069100

Southern Region:
Otis House, MK Towers,
27 Langford Road, Shanti Nagar,
Bengaluru - 560025.
Tel.: +91-080-22111190 / 40314500

Western Region - Area Operations:
1st Floor, Amar Synergy Building,
Next to Vijay Sales & Sadhu Vaswani
Chowk, Near Pune Railway Station,
Pune - 411001.
Tel.: +91-020-67045100

MANUFACTURING:
Bengaluru:
No.92, Kiadb Industrial Estate,
Phase II, Jigani Industrial Area,
Anekal Taluk, Bangalore - 560105.
Tel.: +91-080-7825401 / 5402 / 5403
Email: response@otis.com

SERVICE CENTRES:

Western Region:
Mumbai, Navi Mumbai, Thane,
Nashik.

Eastern Region:
Agartala, Angul, Bhubaneswar,
Bokaro, Dhanbad, Durgapur,
Guwahati, Jamshedpur,
Jhadsuguda, Kahalagaon, Kolkata,
Patna, Ranchi, Shillong, Siliguri.

Northern Region:
Agra, Aligarh, Allahabad, Amritsar,
Bareilly, Chandigarh, Dehradun,
Ghaziabad, Gurgaon, Gwalior,
Haridwar, Jalandhar, Jaipur, Jodhpur,
Jammu, Kanpur, Kota, Ludhiana,
Lucknow, Meerut, Moradabad,
New Delhi, Noida, Rohtak, Shimla,
Shaktinagar, Sonebhadra, Srinagar,
Udaipur, Varanasi.

Southern Region:
Bengaluru, Calicut, Chennai,
Coimbatore, Ernakulam, Erode,
Hubli, Hyderabad, Kaiga, Kottayam,
Madurai, Mangalore, Mysore,
Ootakamund, Pondicherry,
Quilon, Ramagundam, Salem,
Thiruvananthapuram, Thirunelveli,
Trichy, Trichur, Vellore, Vijaywada,
Vishakapatnam.

Western Region - Area Operations:
Ahmedabad, Ankleshwar,
Aurangabad, Bhopal, Goa, Indore,
Jabalpur, Kolhapur, Korba, Nagpur,
Pune, Rajkot, Raipur, Solapur, Surat,
Vadodara, Valsad.



www.otis.com

IN- EN - 0818

© 2018 Otis Elevator Company

